

OWNER'S MANUAL

TO BE USED FOR ALL AUTO-ORDNANCE M1 CARBINES

M1
CARBINE

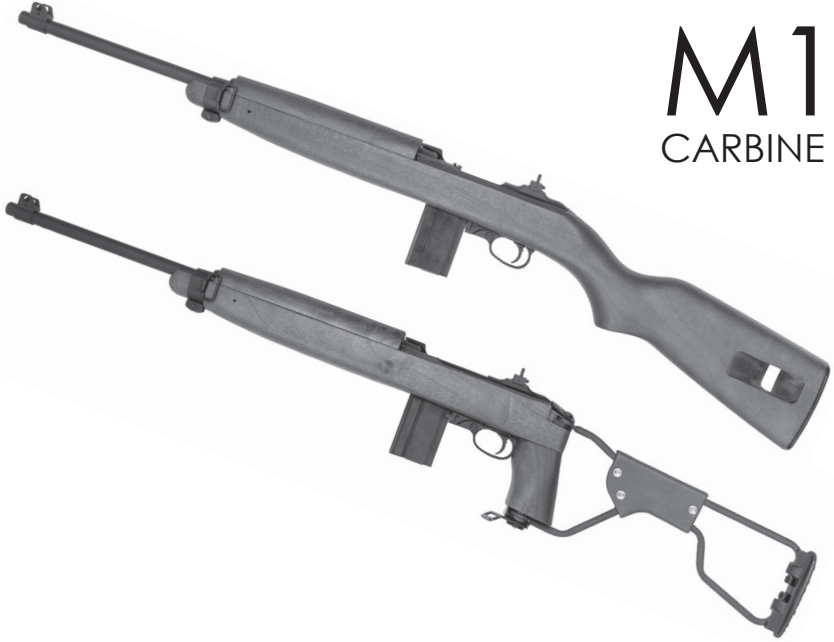

As the owner of a firearm, you must undertake the full-time responsibility of safe firearm handling for your own safety and the safety of those around you. Before handling any firearm read and understand the information contained in its owner's manual.



Be certain this owner's manual is available for reference and is kept with this firearm if transferred to another party. If the manual is lost or misplaced, write directly to Kahr Arms for a free replacement copy.

SAFETY AND SAFE FIREARM HANDLING IS EVERYONE'S RESPONSIBILITY.

Auto-Ordnance

Auto-Ordnance Corporation

Factory: 130 Goddard Memorial Drive, Worcester, MA 01603

Sales Support & Service: 508-795-3919 / Fax: 508-795-7046

Web Address: www.auto-ordnance.com

TABLE OF CONTENTS

Contents	Page
USER SAFETY WARNINGS & RESPONSIBILITY	3-4
LOCKING DEVICES	5
NOMENCLATURE	6
INSTRUCTION FOR USE	7
OPERATION OF SAFETY	7
MAGAZINE	8
LOADING AND FIRING	8
CLEANING, LUBRICATING, AND MAINTENANCE	9
DISASSEMBLY PROCEDURE	10
REASSEMBLY PROCEDURE	11
SHIPPING FIREARMS FOR SERVICE	12
GENERAL PRECAUTIONS	12
PARTS LIST & EXPLODED VIEW, MODELS: AOM130, AOM140 & AOM150	14-15
ORDERING PARTS AND ACCESSORIES	15
PAYMENT FOR PARTS AND ACCESSORIES	15
WARRANTY	Back Cover

AUTO-ORDNANCE M1 CARBINE SPECIFICATIONS

WALNUT STOCK

Models: AOM130

AOM140 (California Approved)

WALNUT FOLDINGSTOCK

AOM150

Caliber:30 Caliber
Barrel:	18"
Length:	35 3/4" overall
Weight:	5.4 lbs (AOM130/AOM140, CA Approved), 5 lbs 6 oz (AOM150)
Construction:	Parkerized steel receiver, wood stock and handguard
Finish:	Parkerized
Sights:	Blade front sight, flip style rear sight
Stock:	Walnut (AOM130/AOM140, CA Approved), Walnut folding stock (AOM150)
Magazine:	One 15 Shot stick (AOM130/AOM150), One 10 Shot stick (AOM140, CA Approved)

USER SAFETY WARNINGS & RESPONSIBILITY

IMPORTANT SAFETY WARNINGS — NOTE THE SYMBOL



These safety warnings are for your protection as well as the safety of others. Disregarding information in this manual may result in serious injury or death.



STOP! Do not attempt to load or use any firearm until you read and understand the information contained in its owner's manual. Before handling your firearm, you should learn how it operates and how to maintain it. This includes knowing its basic parts, how the manual safety and other safety features operate, how to safely open and close the action and how to safely load and unload ammunition from the firearm. Improper use and handling is dangerous and could cause severe injury or death to you or those around you. All users of the firearm must become thoroughly familiar with the instructions in this manual.

Be certain this owner's manual is available for reference and is kept with this firearm if transferred to another party. If the manual is lost or misplaced, write directly to Kahr Arms for a free replacement copy.



As the owner of a firearm, you must undertake the full-time responsibility of safe firearm handling for your own safety and the safety of those around you:

- Keep all firearms and ammunition out of the reach of children.
- Store your firearms and ammunition separately.
- Never store a loaded firearm.
- Never leave a loaded firearm unattended.
- Never transport a loaded firearm in a vehicle.



REMEMBER: A firearm's safety is a mechanical device which can never replace safe firearm handling. Safe firearm handling depends on you!



Always point the muzzle of your firearm in a safe direction, regardless of whether the firearm is loaded or unloaded. You should become thoroughly familiar with the function and operation of this firearm and the instructions supplied with it.



Always treat every firearm as if it were loaded. Give your firearm to someone with the action open and safety in the "on" (safe) position after you verify the firearm is unloaded. Insist on the same procedure when receiving a firearm from someone else. Learn the location of all the safety features of your firearm and how they operate.

You have a responsibility to obtain proper training on how to use and maintain your firearm. Certified and reputable safety courses and instructions are offered by The National Rifle Association (NRA) as well as by state and local organizations. You also have a responsibility to know and obey all local, state and federal laws governing the use, possession and transportation of firearms.



To protect yourself and others from injury, use the correct brass case ammunition in the caliber referenced by the markings on top front of the receiver. Auto- Ordnance firearms are designed, manufactured and proof tested to recommended Sporting Arms and Ammunition Manufacturers Institute (SAAMI) standards for factory loaded ammunition.

We specifically disclaim responsibility for any damage or injury whatsoever occurring in connection with, or as the result of, the use in Auto-Ordnance firearms of cartridges other than those for which the firearm was originally chambered. Additionally, we disclaim any responsibility for damage or injury which results from any modifications or changes that are not a part of the firearm as delivered from the factory.



Learn how to clean your firearm thoroughly and make certain no oil, grease or other materials are blocking the barrel. Obstructions of any kind can cause damage to the firearm resulting in personal injury.

Practice proper firearm maintenance and safety. Make sure all exposed metal surfaces are coated with a thin film of oil, especially after being exposed to damp weather. Before using after storage, follow complete instructions stated in this manual for refamiliarization with the firearm. A thorough inspection should be performed before shooting the firearm. A clean dry patch should be run through the barrel ensuring removal of any obstructions or excess oil.



Wear eye and ear protection when shooting. Shooting without proper ear protection can cause hearing damage. The use of eye protection during any type of shooting is important to protect your vision.



Never climb or jump over an obstacle with a loaded firearm. Never pull a firearm toward you by the muzzle. Never shoot towards a flat, hard surface or water. Always be sure of your target and what is beyond it.



When handling your firearm, never allow fingers or any object to touch the trigger until you are ready to shoot.



The safety should always be in the “on” (safe) position until you are ready to shoot. It is a mechanical device and should never be used as an excuse for careless handling or unsafe practices.



Make sure you read, understand and follow the firearm safety rules that are listed in this manual.



The use of a locking device or safety lock is only one aspect of responsible firearm storage. Firearms should be stored unloaded and locked in a location that is both separate from their ammunition and inaccessible to children and other unauthorized persons.

LOCKING DEVICES



This firearm was originally sold with a key-operated locking device. While it can help provide secure storage for your unloaded firearm, any locking device can fail. All firearms are designed to fire if they are loaded and the trigger is pulled. Therefore, never install the locking device inside the trigger guard or in any way that it can possibly pull the trigger! Do not leave the keys in the lock.

The ultimate responsibility for secure storage of any firearm must depend upon its owner and his or her individual circumstances. Guns should be securely stored unloaded, in a secure location, separate from their ammunition.

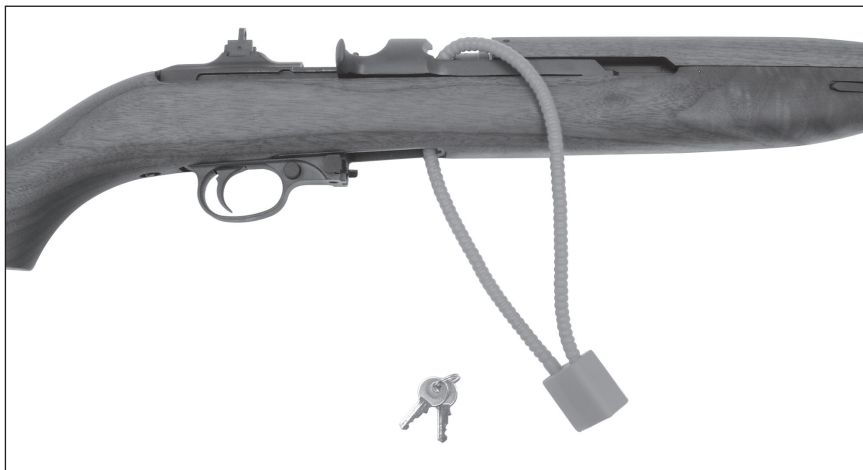

IT IS IMPERATIVE THAT YOU KEEP THIS FIREARM LOCKED IN A SECURE PLACE AND TAKE OTHER STEPS NECESSARY TO LIMIT THE POSSIBILITY OF THEFT OR ACCIDENT. FAILURE TO TAKE REASONABLE PREVENTIVE STEPS MAY RESULT IN INNOCENT LIVES BEING LOST AND, IN SOME CIRCUMSTANCES MAY RESULT IN YOUR LIABILITY FOR THESE DEATHS.

Auto-Ordnance NOMENCLATURE

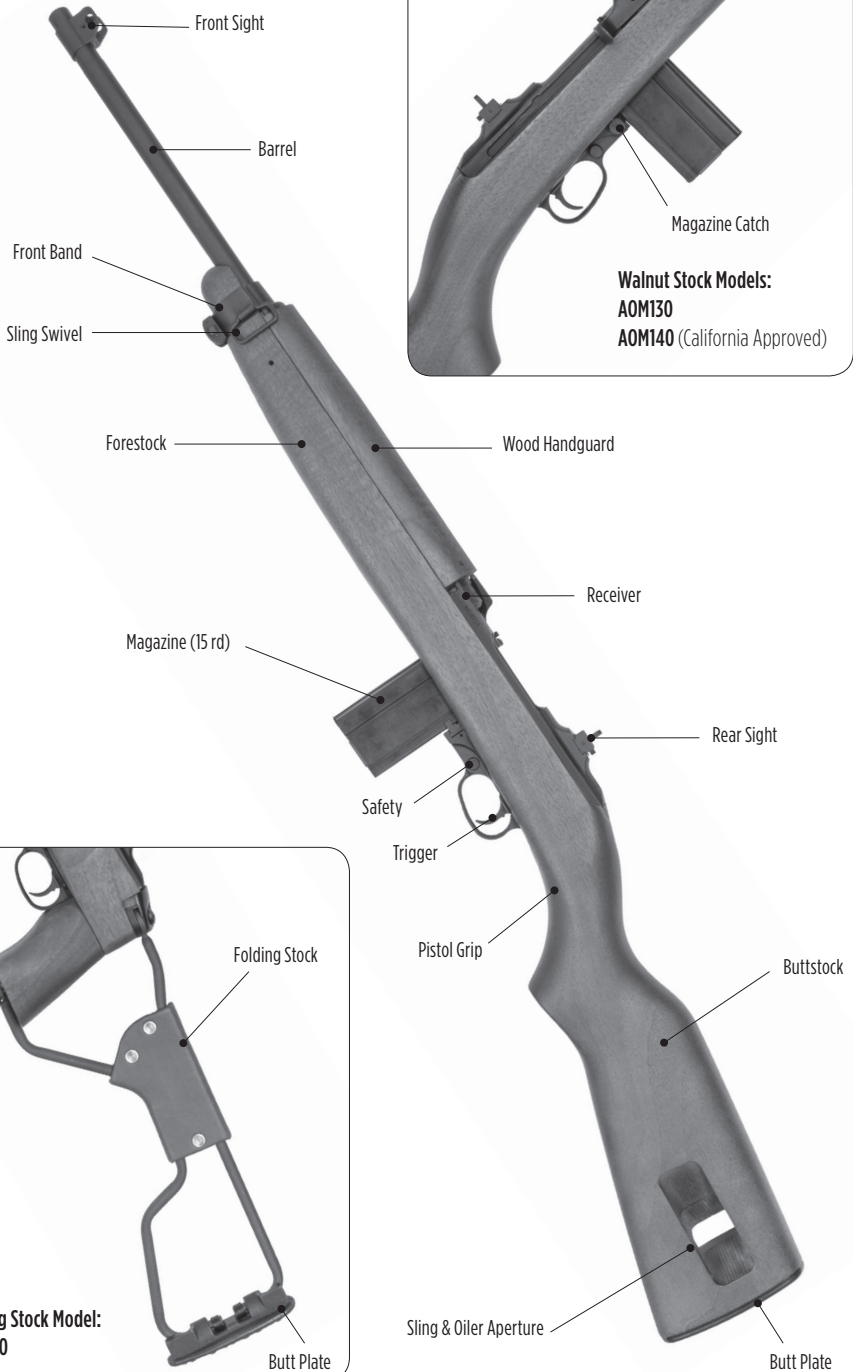

INSTRUCTION FOR USE

Read and understand this manual before removing this firearm from its package. Pay special attention to safety instructions and procedures, which appear in the safety chapter of this manual. Failure to adhere to safety information could result in property damage, personal injury or death.



Always assume that this firearm is loaded and capable of being discharged until the magazine is removed and you have inspected the chamber and completed the unloading procedures.

To reduce the possibility of an accidental discharge, do not place your finger on the trigger until the firearm is pointed at your intended target. Any firearm, including this carbine should be considered dangerous and must not be accessible to unauthorized persons especially children.



Prior to loading and firing, carefully read all instructions in this safety manual for basic advice on the proper handling and functioning of this firearm. Your safety and the safety of others (including your family) depend on your mature compliance with this advice and your adoption, development and constant employment of SAFE PRACTICES. If unfamiliar with firearms in general, seek further advice through safe-handling courses run by your local gun clubs, from approved instructors or from similarly qualified organizations such as the NRA.

NOTICE: We want you to enjoy shooting your carbine but we want you to enjoy it safely. You may already be an experienced safe shooter, familiar with the procedures in this instruction manual, or you may never have handled a firearm before. Either way, we urge you to read this entire instruction manual carefully. It is essential to follow the instructions for your safety and the safety of others.



This carbine has several mechanical safety features, all designed to prevent an accidental discharge should the rifle be dropped or receive a severe blow. Therefore, extra care and strict adherence to the safety instructions and other instructions contained within this manual are mandatory for minimizing the risk of accidents. However, like any other mechanical device, when subjected to extreme forces not normally encountered in sport shooting, law enforcement or military use, a partial failure could occur. The proper and safe function of this carbine is based on the premise that no parts are altered or modified, and that the carbine is used for its intended purpose.

OPERATION OF SAFETY

The manual safety is located on the trigger housing between the trigger and the magazine catch. It must be moved manually by the shooter. To put the safety in the “SAFE” (on) position, the safety must be pushed fully from left to right. To put the safety in the “FIRE” (off) position, the safety must be pushed fully from right to left.



Always set your carbine on safe position when not in use. Remember, a firearm's manual safety is a mechanical device which can never replace safe firearm handling and storage practices.

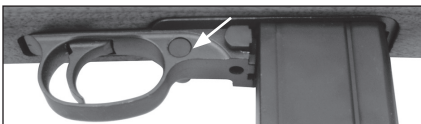

FIRE POSITION

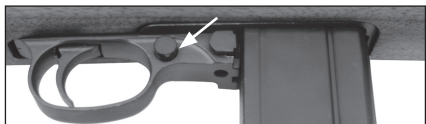

SAFETY ON POSITION

MAGAZINE

Loading the Magazine

Use only factory loaded brass case ammunition of the proper caliber manufactured to US Industry and SAAMI specifications. To load the stick magazine, align each cartridge with the bullet forward (pointing toward the larger opening in the front of the magazine body) and push downward until the cartridge snaps into place. Do not attempt to load more than the designated number of cartridges for which the magazine has been designed.



DAMAGED, NON-STANDARD, OR IMPROPERLY ASSEMBLED MAGAZINES SHOULD NEVER BE USED. THEY CAN CAUSE A MALFUNCTION, SERIOUS INJURY OR DEATH.

Inserting the Magazine

Holding the carbine with the left hand at the pistol grip, move the safety to the safe position. With the right hand, insert a (fully loaded) magazine into the magazine opening, making sure that it snaps into place. Tap the magazine base to be sure it is seated.

Removing the Magazine

Holding the carbine with the left hand at the pistol grip, move the safety to the safe position. With the right hand grasp the magazine, depress the magazine catch with the right thumb and remove the (empty) magazine. To minimize the possibility of damage and malfunctions, do not let the magazine drop to the ground.



ALWAYS CONFIRM THE SAFETY IS IN THE "SAFE" POSITION WHEN INSERTING OR REMOVING THE MAGAZINE.

LOADING AND FIRING

Practice this important aspect of firearm handling with an unloaded carbine until you can perform each of the steps described below. This procedure begins with an empty carbine with the magazine removed.

1. Be certain the muzzle is pointed in a safe direction down range.
2. Verify the chamber is empty and move the safety to the "SAFE" position (see page 7).
3. Insert the loaded magazine into the receiver and immediately draw the operating slide all the way to the rear and release it, allowing the operating slide to snap forward under full spring tension. A cartridge will be stripped from the magazine and chambered.
4. The carbine is now cocked and a loaded cartridge is in the chamber. Visually confirm that the safety is in the "SAFE" position.
5. When you are ready to fire the carbine move the safety to the "FIRE" position. Never touch the trigger until you are ready to fire. Always keep the safety in the "SAFE" position until you are actually firing the carbine.
6. The carbine will fire one shot each time the trigger is pulled until the magazine is empty. Each time the operating slide is pushed rearward by the energy of the cartridge, a spent case is ejected, the carbine is recocked and a new cartridge is chambered from the magazine into the chamber.
7. Immediately following the firing of a shot if another shot is not to be fired at once, put the safety in the "SAFE" position while the carbine is still pointing in a safe direction down range. The safety should be moved to the "SAFE" position as soon as firing is completed.
8. When the last cartridge in the magazine has been fired the operating slide lock will not remain open.



WARNING: THE UNLOADING SEQUENCE MUST BE FOLLOWED EXACTLY AS SPELLED OUT. FAILURE TO DO SO CAN RESULT IN THE RIFLE'S CHAMBER BECOMING UNINTENTIONALLY LOADED WITH A CARTRIDGE. EVEN THOUGH THE MAGAZINE HAS BEEN REMOVED A CARTRIDGE REMAINING IN THE CHAMBER CAN STILL BE FIRED. ALWAYS VISUALLY CHECK THE CHAMBER.

CLEANING, LUBRICATING, AND MAINTENANCE

At regular intervals, or whenever the carbine has been exposed to sand, dust, extreme humidity, condensation, immersion in water, or other adverse conditions, disassemble, clean and oil it. Proper periodic maintenance is essential to the reliable functioning of any firearm.

Barrels are relatively soft and may be easily damaged. Any damage done to the muzzle will immediately show up on the target. Extreme care must be taken, and thought applied each time the cleaning rod is inserted into the bore. The design of the Carbine receiver prevents traditional cleaning of the bore from the breech end of the barrel. The cleaning rod must be inserted into the bore from the muzzle. Jointed cleaning rods should not be used. The outside diameters of the sections of cleaning rod are not a perfect match at the joints. This mismatch causes abrading of the rifling at the muzzle. Use of a one-piece cleaning rod, coupled with extreme care, will prevent most damage.

To clean the rifle, proceed as follows:

1. Disassemble (field-strip) the carbine to the extent described on page 10.
2. Using a cleaning rod, run a patch wetted with a high quality gun cleaning solution through the bore several times. Then attach a brass bristle brush (steel brushes are not advisable) wetted with a high quality gun cleaning solution to the rod and run it back and forth the full length of the bore and chamber. (Never reverse direction in the bore.) Clean bore with dry patches and examine. Bore fouling can contribute to reduced accuracy, and grease accumulation in the chamber can interfere with proper feeding of cartridges from the magazine.
3. Using a high quality cleaning solvent on a clean patch or bristle brush, remove powder residue from all components of the mechanism. After cleaning, run a dry patch through the bore, then follow with a patch that is very lightly oiled. Wipe all surfaces clean with cloth, then wipe all surfaces with a patch or cloth that has been very lightly oiled.
4. **NOTE:** Only a light application of oil is needed to provide adequate lubrication of moving parts and to prevent rust. Excess accumulations of oil tend to attract particles of dust and dirt and may congeal in cold weather which can interfere with the safe and reliable function of the rifle.



LUBRICATION

FIRING A RIFLE WITH OIL, GREASE, OR ANY OTHER MATERIAL EVEN PARTIALLY OBSTRUCTING THE BORE MAY RESULT IN DAMAGE TO THE RIFLE AND SERIOUS INJURY TO THE SHOOTER AND THOSE NEARBY. DO NOT SPRAY OR APPLY LUBRICANTS DIRECTLY ON AMMUNITION. IF THE POWDER OF A CARTRIDGE IS AFFECTED BY THE LUBRICANT, IT MAY NOT BE IGNITED, BUT THE PRIMER FIRING MAY PUSH THE BULLET INTO THE BORE WHERE IT MAY BE LODGED. FIRING A SUBSEQUENT BULLET INTO THE OBSTRUCTED BORE MAY DAMAGE THE RIFLE AND CAUSE SERIOUS INJURY OR DEATH TO THE SHOOTER AND THOSE NEARBY. USE LUBRICANTS PROPERLY. YOU ARE RESPONSIBLE FOR THE PROPER CARE AND MAINTENANCE OF YOUR FIREARM.

DISASSEMBLY PROCEDURE

1. Retract the operating handle and check chamber to be sure carbine is empty. Return operating handle slowly.

2. Press the magazine catch and withdraw the magazine.

3. Unscrew front band screw part way (see image A), press forward end of locking spring toward stock and slide front band forward (see image B).

4. Slide hand guard forward and lift from barrel.

5. Lift forward end of barrel until receiver lug is disengaged from recoil plate. Lift barrel and receiver group from stock (see image C).

6. Pull operation slide spring guide to the rear, releasing it from its seat in the operating slide. Pull guide clear of the slide and remove it with spring (see image D).

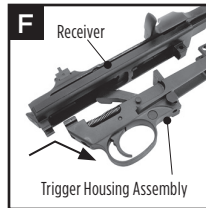
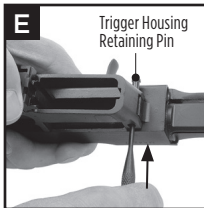
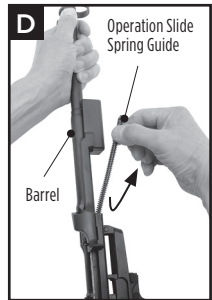
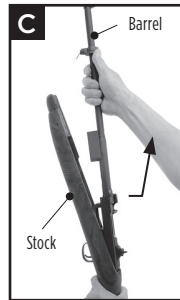
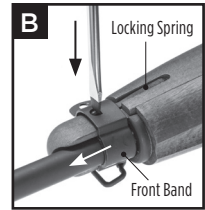
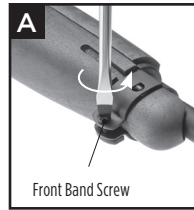

7. Pull the operating handle to the rear, cocking the hammer and return operating handle to forward position.

8. Remove trigger housing retaining pin (see image E) and remove the trigger housing assembly (see image F) from the receiver.

9. Move operating slide handle to the rear, and pull it out until lug is free from retaining groove at right of receiver (see image G). Move operating slide forward with left hand, canting it to the right until lug is free at the notch in the left of barrel (see image H).

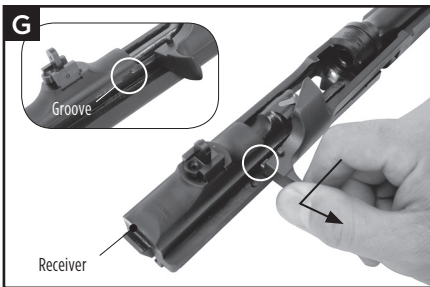

10. Grasp bolt by the locking lug as shown and slide it to rear until front of bolt is behind the locking shoulder in receiver. Rotate the bolt to the left and pull it up until it stops. Turn bolt to the right and lift from receiver (see image I).

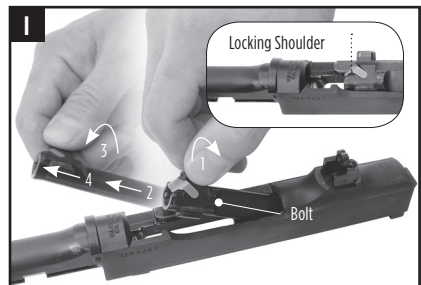
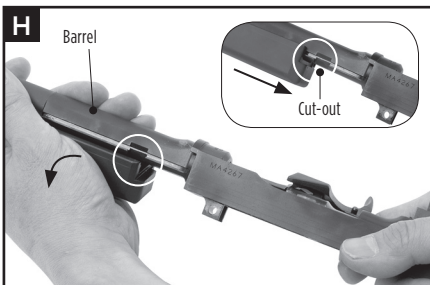

REASSEMBLY PROCEDURE

1. Grasp bolt by the locking lug as shown and insert the rear of bolt in an upright position into rear of opening in receiver. Lower the bolt, turning it to the right until lug engages the groove inside the left side of receiver. Slide the bolt forward to locked position to be sure it works freely (see image J).

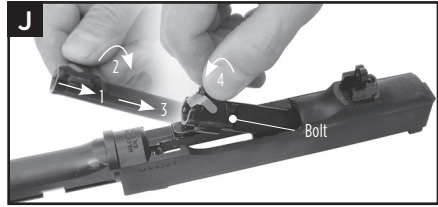

2. Remove bolt from locked position and slide it about half way to rear of opening. Grasp operating slide in left hand and place cammed part over locking lug of bolt. Turn slide to left. Engage the left lug at the notch in left of barrel (see image K). Pull operating handle to the rear until lug enters groove in right side of receiver slide operating handle and push forward until bolt is in locked position (see image L).

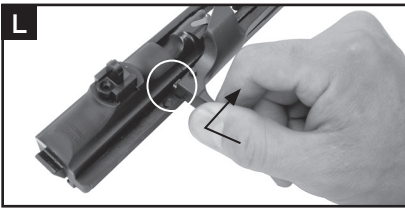
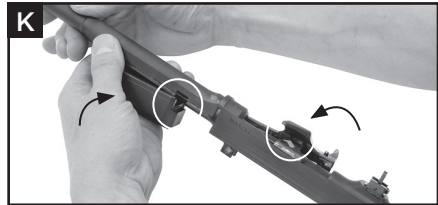

3. Insert guide into operating slide spring. Slide opposite end of operating slide spring into receiver. Compress the operating slide spring with the operating slide spring guide until guide is seated in hole in operating slide (see image M).

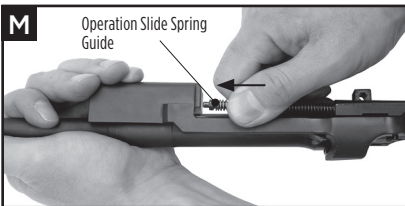

4. Cock the hammer (see image N) place trigger housing group on bottom of receiver and slide group to the rear so that trigger housing lugs engage the receiver. Insert the trigger housing pin from the right.

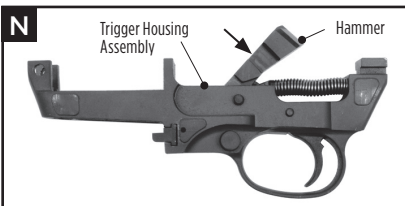

5. Insert receiver end of assembly into stock making sure the receiver lug engages the recoil plate. Lower barrel assembly into stock.

6. Place hand guard liner beneath flange on receiver. Slide the front band to the rear, at the same time pressing spring toward the stock. Slide the band over the stock and hand guard until it is held by the retaining spring (see image O). Tighten front band screw (see image P).

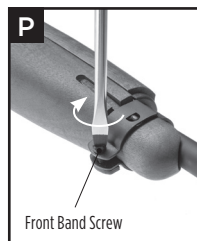
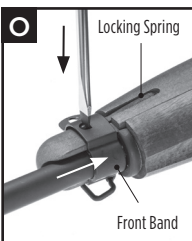

WARNING!

BEFORE SHIPPING ANY FIREARM, BE ABSOLUTELY CERTAIN THAT IT AND ITS MAGAZINE ARE UNLOADED. DO NOT SHIP CARTRIDGES WITH A FIREARM. IMPROPER FITTING PARTS MAY RESULT IN A DANGEROUS MALFUNCTION, DAMAGE TO THE FIREARM, AND INJURY TO THE SHOOTER AND OTHER PERSONS.

IT IS THE RESPONSIBILITY OF THE PURCHASER TO BE ABSOLUTELY CERTAIN THAT PARTS ORDERED FROM THE FACTORY ARE CORRECTLY FITTED AND INSTALLED. THE PURCHASER AND INSTALLER OF PARTS MUST ACCEPT FULL RESPONSIBILITY FOR THE CORRECT ADJUSTMENT AND FUNCTIONING OF THE FIREARM AFTER SUCH INSTALLATION.

SHIPPING FIREARMS FOR SERVICE

Auto-Ordnance carbines returned to the factory for service or repair should be sent to:

Kahr Arms - Service Dept.
130 Goddard Memorial Drive
Worcester, MA 01603

You may obtain a RA# by visiting www.auto-ordnance.com and submitting a request for a RA# using the web form or contact Kahr Customer Service at tel: 508-795-3919 or fax: 508-795-7046 requesting a "return authorization" number. Firearms shipped to the factory must be sent prepaid. THE KAHR SERVICE DEPARTMENT CAN NOT ACCEPT COLLECT SHIPMENTS.

The Federal Firearm Control Act does not prohibit an individual from shipping a firearm directly to the manufacturer for service or repair. However, some states or localities prohibit this. If you live in such a location, have a Federally Licensed Firearms dealer ship the firearm. It will be returned to the dealer after being serviced. Enclose a letter that includes reference to the factory "Return Authorization" Number, your name, address, telephone number, and serial number and model of the firearm. Describe in detail the trouble you have experienced with your firearm, or the work you wish to have done. Stating only that the firearm "needs repair" is inadequate information. Please enclose copies of any previous correspondence.

Please do not include slings, or special accessories with any firearm being shipped to the factory for service. Service work performed, other than approved Warranty repairs, will carry a minimum charge of \$65.00 plus a \$15.00 return shipping and handling charge.

Retain your tracking number when shipping firearms for repair. This will allow you to track the status of your firearm shipment either by phone or the website of the carrier.

GENERAL PRECAUTIONS

1. Always handle your firearm as if it were loaded so that you never fire accidentally.
2. Never point your firearm at anything you do not intend to shoot.
3. Never take anyone's word that a firearm is unloaded. Check for yourself with your finger off the trigger and the gun pointed in a safe direction.
4. Always be sure the barrel and action are clear of obstructions. Clear any obstructions immediately so that the rifle will function correctly and safely.
5. Never squeeze the trigger or put your finger in the trigger guard until you are aiming at the target you intend to shoot.
6. For storage: Unload the firearm, then, after verifying that the firearm chamber is empty and the magazine has been removed, point the firearm in a safe direction and pull the trigger. Store the firearm in a secured place away from children.
7. Never shoot at a hard surface such as a rock or a liquid surface such as water. A bullet may ricochet and travel in any direction.
8. Always be sure your backstop is adequate to stop and contain bullets before beginning target practice.

9. Always be absolutely sure of your target and the area behind it before you squeeze the trigger. A bullet could travel through or past your target for up to 11/2 miles. If in doubt, do not shoot.

10. Always place a responsible and competent person in charge to maintain safety, discipline, and control when a group is firing on a range to reduce the likelihood of accidents.

11. Always carry your firearm empty and open while on a public or club range until preparing to fire. Keep it pointed down range during loading firing and unloading.

12. Never leave a firearm unsecured and unattached. Someone, especially a child, may fire it believing it to be a toy.

13. Never use your firearm if it fails to function properly, and never force a jammed action as the jammed round may explode.

14. Failure to fire: always hold the firearm pointed down range and wait 30 seconds should the firearm fail to fire. If a hang fire (slow ignition) has occurred, the round will fire within 30 seconds. If the round does not fire, remove magazine, eject round and examine primer. If firing pin indent on primer is light off center or nonexistent, have the rifle examined by a competent gun smith. If firing pin indent on primer appears normal (in comparison with empty cases from previous fired rounds) assume faulty ammunition. Reload and carry on firing. NOTE: Dispose of misfired rounds in accordance with ammunition manufacturer's instructions.

15. Never fire your firearm near an animal unless it is trained to accept the noise. An animal's startled reaction could injure it or cause an accident.

16. Never walk, climb, follow a companion or hunt with your firearm ready to fire.

17. Never drink alcoholic beverages or take drugs before or during shooting. Your vision and judgement could be seriously impaired, making firearm handling unsafe.

18. Always seek your doctor's advice if you are taking medication to be sure you are fit to shoot and handle your firearm safely.

19. Always wear ear protection when shooting.

20. Always wear protective shooting glasses for eye protection.

21. Always make sure your firearm is not loaded before cleaning, storing, traveling or handing it to another person.

22. Always keep clear and keep others clear of the ejection port as spent cartridges are ejected with enough force to cause injury. Never place fingers in ejection port or on a hot slide or barrel during or after firing as they could be burned by hot metal.

23. Never place fingers in ejection port as they could be injured.

24. Use only high quality, commercially manufactured ammunition in excellent condition and in the caliber of your firearm. Use of reloaded ammunition will void the warranty.

CAUTION: TO MINIMIZE RISK OF UNINTENTIONAL DISCHARGE AND DAMAGE, LOAD LIVE AMMUNITION INTO FIREARM ONLY WHEN YOU ARE ABOUT TO SHOOT.

NOTICE: Auto-Ordnance shall not be responsible for injury, death, or damage to property resulting from either intentional or accidental discharge of this firearm or from its function when used for purposes or subjected to treatment for which it was not designed. Auto-Ordnance will not honor claims involving this firearm that result from careless or improper handling, unauthorized adjustment or parts replacement, corrosion, neglect, the use of wrong caliber ammunition, the use of ammunition other than original high quality commercially manufactured brass case ammunition in good condition or any combination thereof.

Auto-Ordnance will not honor claims involving this firearm for any reason when the second or subsequent owner makes such a claim.

IMPORTANT: This firearm was tested carefully, inspected and packaged before leaving the factory. Auto-Ordnance cannot control product handling after it leaves the factory. Therefore, please examine this firearm carefully at the time of purchase to ensure that it is unloaded and undamaged. The dealer will be pleased to assist you in making the examination and endeavor to answer your further questions. This instruction manual should always accompany this firearm and be transferred with it upon change of ownership.

MODELS: AOM130, AOM140 and AOM150 PARTS LIST

Key Description	Parts #
1 Receiver	MC002
2A Rear Flip Sight Assembly	MC059AS
2B Rear Sight Assembly (Adjustable)	MC003AS
3 Barrel with Integral Gas Cylinder	MC001
4 Front Band Assembly (Narrow)	MC070AS
5 Front Band Screw (Long)	MC055
4A Front Band Assembly (Wide)	MC114AS
5A Front Band Screw (Short)	MC117
6A Front Sight	MC014
6B Front Sight Pin	MC015
6C Front Sight Key	MC016
7 Piston	MC017
8 Piston Nut	MC018
9 Operating Slide Spring	MC023
10 Operating Slide Spring Guide	MC022
11 Operating Slide	MC019
12 Operating Slide Stop Plunger	MC020
13 Operating Slide Stop Plunger Spring	MC021
17A Wood Handguard Assembly (Walnut)	MC081
17B Stock Assembly (Walnut)	MC082AS
17C Buttplate	MC048
17D Buttplate Screw	MC049
17E Front band lock spring	MC050
18 Recoil Plate	MC011
19 Recoil Plate Screw	MC012
20 Recoil Plate Screw Escutcheon Nut	MC013
21B Magazine, 10 Rd., NEW	MC071AS
21C Magazine, 15 Rd., NEW	MC041AS
22 Folding Stock Assembly (Walnut)	MC095AS

RECEIVER, BARREL & STOCK ASSEMBLIES

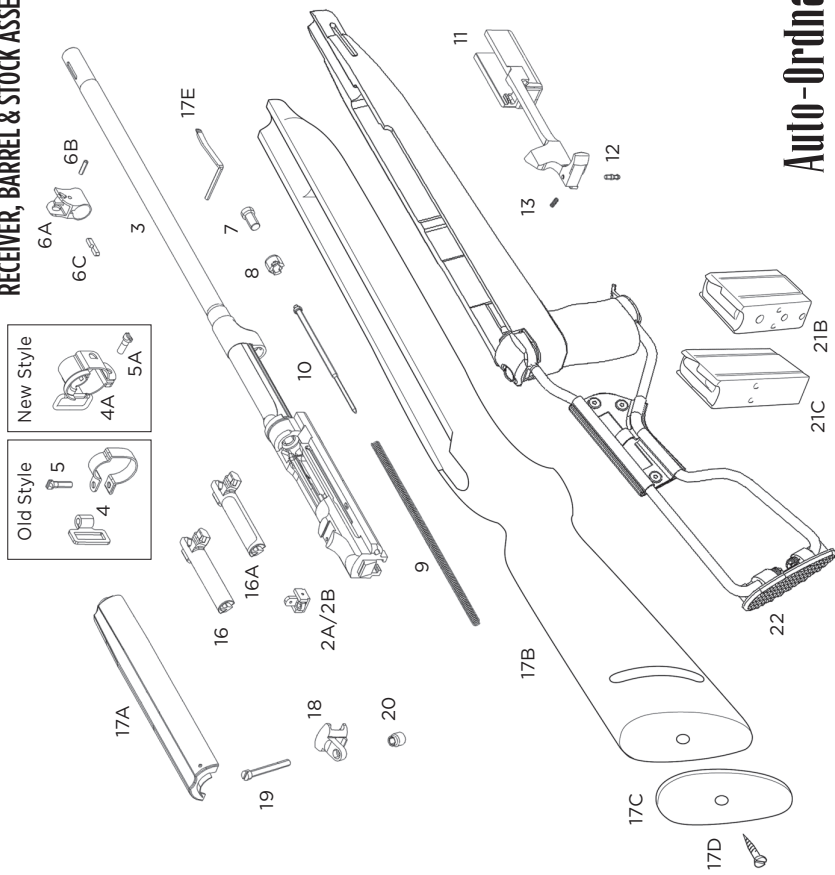

Auto-Ordnance

ORDERING PARTS AND ACCESSORIES

Order parts by Part Name and Part Number. Please refer to the separate order sheet and price list included with the firearm packaging to place orders. Orders

for Auto-Ordnance parts can be processed by mail, fax or at www.auto-ordnance.com. We do not process phone orders. Prices and availability can be verified by phone. When ordering specify the model, caliber, finish and entire serial number of the firearm - including all letters and numbers. Note: many parts are common to all firearms regardless of model finish. Order accessories by Item Name and Item Number. All parts and accessory orders should be mailed or faxed to:

Kahr Firearms Group

Attn: Web Shop Department

105 Kahr Ave., Greeley, PA 18425 | Fax: 570-685-2222

WE DO NOT PROCESS PHONE ORDERS.

PAYMENT FOR PARTS AND ACCESSORIES

All orders require prepayment - by check, money order or credit card authorization. Parts and accessories can be ordered online at www.auto-ordnance.com. KAHR ARMS cannot offer individuals open account or COD requests.

Include \$6.00 for shipping and handling on parts orders totaling \$50.00 or less. Include \$9.00 on parts orders totaling more than \$50.00.

BOLT ASSEMBLY		TRIGGER ASSEMBLY	
16 Bolt Assembly - Round.....	MC004AS	14 Trigger Housing.....	MC025
16A Bolt Assembly - Flat Top.....	MC079	14A Trigger Housing Assembly.....	MC025AS
16B Firing Pin.....	MC005	14B Safety - Push.....	MC052
16C Extractor N/T Plated.....	MC006NT	14C Magazine Catch.....	MC038
16D Extractor Plunger.....	MC007	14D Magazine Catch Plunger Spring.....	MC040
16E Extractor Plunger Spring.....	MC008	14E Magazine Catch Plunger.....	MC039
16F Ejector Plunger.....	MC009	14F Safety & Magazine Plunger (2).....	MC036
16G Ejector Plunger Spring.....	MC010	14G Safety & Magazine Plunger Spring.....	MC037
		14H Hammer Spring.....	MC029
		14I Hammer Spring Plunger.....	MC028
		14K Hammer.....	MC026
		14L Hammer Pin.....	MC027
		14M Trigger.....	MC030
		14N Trigger Spring.....	MC031
		14O Sear.....	MC032
		14P Sear Spring.....	MC034
		14Q Trigger & Sear Pin.....	MC033
		15 Trigger Housing Retaining Pin.....	MC024

Limited One-Year Warranty

Auto-Ordnance M1 Carbine

This "LIMITED ONE-YEAR WARRANTY" has been drafted to comply with the MAGNUSON-MOSS WARRANTY FEDERAL TRADE COMMISSION IMPROVEMENT ACT which is effective for goods manufactured on or after December 31, 1976.

KAHR ARMS / AUTO-ORDNANCE warrants that this firearm was originally manufactured free of defects in material or workmanship. For one year from date of purchase of the original purchaser, KAHR ARMS agrees to correct any defect in this firearm for the original purchaser by repair or replacement (with same or comparable quality model). A service and/or handling charge may be applied.

THIS WARRANTY IS VOID IF THE FIREARM HAS BEEN ABUSED, MISUSED, DAMAGED BY ACCIDENT, FIRED WITH HANDLOADED AND/OR RELOADED OR IMPROPER AMMUNITION OR WITH AN OBSTRUCTION IN THE BARREL, OR DAMAGED THROUGH FAILURE TO PROVIDE REASONABLE AND NECESSARY MAINTENANCE AS DESCRIBED IN THIS MANUAL. THIS WARRANTY DOES NOT APPLY TO NORMAL WEAR OF ANY PARTS, INCLUDING METAL, WOOD, PLASTIC, RUBBER AND OTHER MATERIAL'S SURFACE FINISH OR IF UNAUTHORIZED REPAIR AND/OR ALTERATION HAS BEEN PERFORMED.

The terms of the Warranty cannot be changed except in writing by an officer of KAHR ARMS. Wholesalers and Dealers (unless a KAHR ARMS authorized Warranty repair station) are not authorized to make any Warranty repair or adjustment on behalf of KAHR ARMS.

This Warranty gives only the original retail purchaser specific legal rights. Other rights may also be available which may vary from state to state. Should repair be required for this firearm, a "Return Authorization" number is required. You may obtain a RA# by visiting www.auto-ordnance.com and submitting a request for a RA# using the web form or contact Kahr Customer Service at tel: 508-795-3919 or fax: 508-795-7046 requesting a "Return Authorization" number. Please include with the returning firearm a brief description of the defect or malfunction, date of purchase and dealer from whom the firearm was purchased. Then, send the unloaded firearm, prepaid via UPS GROUND or FEDEX GROUND, with a copy of the sales receipt and "Return Authorization" number to:

Kahr Arms – Service Dept.
130 Goddard Memorial Drive
Worcester, MA 01603
E-mail Address: service@kahr.com
Web Address: www.auto-ordnance.com